

VACC-SAFE

PHARMACY REFRIGERATOR

Product implementation standards:
EN 61010-2-011:2021/A11:2021
EN 61326-1 :2013

EN

Vacc-Safe

USER MANUAL

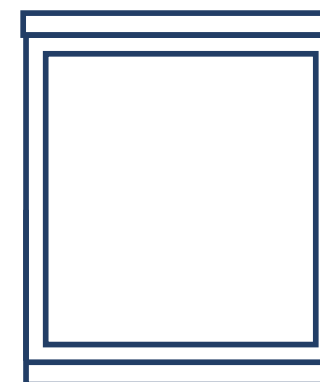

Model: VS150

Vacc-Safe

1300 459 140



Warning:
Before using this product,
please read this manual carefully
and keep it for future reference.
The design and specifications
are subject to change without
prior notice for product
improvement. Consult with your
dealer or manufacturer for
details.

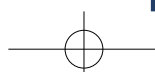
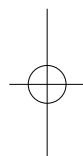
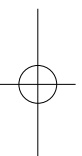

Table of Contents

1. Product Features -----	01
2. Safety Precautions -----	02
3. Precautions for Use -----	05
4. Product Installation-----	06
5. Product Components and Overview-----	09
6. Operating Instructions-----	10
7. Alarm Description-----	13
8. Maintenance -----	14
9. Troubleshooting and Repair Service -----	15
10. Specifications -----	16
11. Packing List-----	16
12. Electrical Schematic Diagram -----	17

Product Features

This product can be used to store human testing samples, drugs, vaccines, biological products, reagents, etc., as well as items that need to be stored at the ambient temperature of 2~8°C.

Product Functions

Accurate Temperature Control Data Traceability

- Microcomputer temperature control, with a display accuracy of 0.1°C
- Temperature fluctuation range in the refrigerator: $\leq 2^{\circ}\text{C}$, with an adjustable temperature range of 2~8°C, and accurate temperature control
- Optional USB interface

Efficient Refrigeration Energy-efficient and Quiet

- Well-known internationally branded compressor, ensuring energy conservation, environmental protection, high efficiency and quietness
- Famously branded and efficient vortex evaporator fan for refrigeration, with stable and consistent performance and low noise, ensuring more uniform and stable temperature in the refrigerator and a more efficient cooling rate

Multiple Alarms Safety and Stability

- Perfect acoustic and optical alarm function, allowing high and low-temperature alarms, power failure alarm, sensor fault alarm, etc. with alarm values adjustable on demand
- Safety door lock design, ensuring the safety of samples in the refrigerator

Humanized Design

- Multi-layer shelf design with adjustable height, maximizing space utilization
- Built-in LED lamp, highly bright and energy-saving, making the contents inside the refrigerator clearly visible
- 198~242 V wide voltage range design, ensuring stable equipment operation

Safety Precautions

Dear Midea users:

To whom it may concern: Thank you for using Midea medical refrigerator. Please carefully read the following information to better understand the Operation Instructions and use this product, so as to prevent personal injury and damage to items.



Warning

Ignoring WARNING items may result in serious casualties.



Acts or operations that must be prohibited



Caution

Ignoring CAUTION items may result in casualties or damage to the medical refrigerator and related property loss.



Actions or operations that must be followed



This symbol on the product indicates "prevent fire, keep away from fire source".



This symbol on the product indicates "prevent pinching".



Warning



Please use a power socket with a grounding wire to prevent electric shock. If the power socket is not grounded, the grounding wire must be installed by professional technicians.



Be sure to place the refrigerator firmly on solid and flat ground. If the floor is not level or the refrigerator is placed in an improper location, the refrigerator may tip over or cause injuries.



If the power cord needs to be extended, the cross-sectional area of the extension cord shall not be less than 2 mm² and the length shall not be more than 3 m. Otherwise, fire or electric shock may occur.



In case of leakage of coal gas and other flammable gases, close the leaking valve, and open doors and windows for ventilation and gas release. Do not plug or unplug the power plug of the refrigerator; otherwise, an explosion and fire may occur.



Only professional technicians or maintenance personnel for after-sales support are allowed to disassemble and assemble the refrigerator. Otherwise, an electric shock may occur and develop further into a fire.

















Please use the special power supply indicated on the nameplate of the refrigerator; otherwise, a fire or electric shock may occur.







If the applied voltage is lower than 198 V or higher than 242 V, an automatic voltage regulator of over 4,000 W suitable for the motor load needs to be installed for assistance.













The power cord of this refrigerator is equipped with a three-wire (grounded) plug to mate with a standard three-wire (grounded) 10 A socket.

-  Under no circumstances should the ground pin of the power cord be cut or removed. Make sure that the power plug and the socket are connected firmly and securely; otherwise, a fire may occur.
-  When unplugging the plug from the power socket, hold the plug tightly instead of pulling the wire of the plug.
If the wire is pulled, an electric shock or a fire due to a short circuit may occur.
-  If the refrigerator is not operating properly, unplug the power plug. Continued operation under abnormal conditions may cause an electric shock or fire.
-  Before any repair or maintenance of the refrigerator, always disconnect it from the power supply to prevent electric shocks or personal injuries.
-  Make sure that the drugs or suspended particles inside and around the refrigerator will not be inhaled during repairs and maintenance; otherwise, they may cause harm to human health.
-  When storing toxic, harmful, or radioactive substances, please use the refrigerator in a safe area. Improper use may cause harm to human health or the environment.
-  Unplug the power plug when the refrigerator is going to be left unused for a long time, so as to prevent electric shocks, electric leakage, or fire due to aging of the power cord.
-  If the refrigerator is going to be left unused in an unattended area for a long time, ensure that children do not have access to the refrigerator. The refrigerator shall be disposed of by the appropriate personnel. The refrigerator door shall be removed to prevent accidents such as suffocation.
-  Never store flammable, explosive, or volatile substances in the refrigerator or use flammable sprays near the refrigerator; otherwise, an explosion or fire may occur.
-  Never store corrosive substances such as acids or alkalis in the refrigerator. Otherwise, these substances may cause damage to internal components or electrical parts of the refrigerator.
-  Do not leave the plastic packing bag in a place accessible to children as this may result in suffocation accidents.
-  Do not climb on the refrigerator or put any object on the refrigerator; otherwise, the refrigerator may tip over and cause personal injuries or damage to the refrigerator.
-  Do not use the refrigerator outdoors. Exposure to rain may cause an electric leakage or electric shock.
-  Do not place the refrigerator in a humid location or a place where the refrigerator is likely to be hit by splashing water. Otherwise, an electric leakage or electric shock may occur due to reduced insulation.
-  Do not pour water directly onto the refrigerator; otherwise, it may cause an electric shock or short circuit.

-  Never disassemble, repair, or modify the refrigerator yourself. Otherwise, fire or personal injuries may occur due to improper operation.
-  Do not connect the grounding wire to a gas pipe, power supply pipe, telephone line, or lightning rod when grounding the refrigerator. The above connection may cause an electric shock or other hazards.
-  Do not touch any electrical parts such as the power plug or operate any switch with a wet hand; otherwise, an electric shock may occur.
-  Do not put water containers or heavy objects on the refrigerator. Falling objects may cause personal injuries, and spilled water may cause reduced insulation, resulting in an electric leakage or electric shock.
-  Never insert metal objects such as iron nails and metallic wires into any hole, gap, or air outlet on the refrigerator; otherwise, electric shocks or injuries may occur due to accidental contact between these objects and moving parts.



-
-  Keep the refrigerator clear of obstructions around it to ensure good ventilation. When it is necessary to restart the refrigerator after power outage or the refrigerator is turned off, check the settings of the refrigerator.
 -  Changes in settings may deteriorate the items being kept.
 -  Once the power is cut off, the refrigerator can only be re-energized after more than five minutes to avoid damage to the compressor or the system.
 -  Gloves shall be worn during maintenance to avoid directly touching sharp edges or corners and causing injuries to personnel.
 -  Hold the handle to close the refrigerator door so that the door does not pinch fingers.
 -  Tilt the refrigerator for 45° or less when handling or moving it.
 -  Be careful not to be tripped over by the refrigerator when handling it to prevent damage to the refrigerator or personal injuries.
 -  Do not use the door handle to lift or carry equipment to prevent damage to the refrigerator or personal injuries.
 -  Do not damage the refrigeration circuit.
 -  Do not use electrical appliances inside the cabinet of the refrigerator, unless they are of the type recommended by the manufacturer.

Precautions for Use

- ★ Before putting items into the equipment, confirm that the temperature in the cabinet has reached the set temperature, and then put the items in batches. Do not put in items for more than 1/3 of the volume of the refrigerator at a time to prevent its temperature from rising too much.
- ★ The displayed temperature of the equipment is the temperature at the temperature sensor in the cabinet. When the equipment just starts to run, the displayed temperature is somewhat different from the actual temperature at the center of the equipment. However, after the equipment enters a stable status, the displayed temperature will gradually approach the actual value.
- ★ The refrigerator is designed with a testing hole so that the test line inside the refrigerator can be led out for testing. After leading out the test line, be sure to re-plug the testing hole with thermal insulation material. Otherwise, the temperature inside the refrigerator may not reach the set value, causing condensation around the outside of the through-hole.
- ★ Please use diluted neutral cleaner to clean the equipment. Do not use brushes, acid, gasoline, soap powder, polish or hot water to clean the equipment; otherwise, the painted surface and plastic/rubber parts may be damaged. Special care must be taken not to use volatile solvents such as gasoline to wipe plastic/rubber parts.
- ★ Cut off the power when the equipment is going to be left unused for a long time.
- ★ Try to reduce the opening time of the door each time when you take or put items to avoid large fluctuations in temperature and humidity inside the refrigerator.
- ★ After the door is opened, the temperature inside the refrigerator will rise sharply for a short time, which is normal, and will recover within 1 hour after the door is closed.
- ★ In a high-temperature and high-humidity environment, condensation may occur on the glass door, which is a normal phenomenon and does not affect the storage temperature in the refrigerator. If condensation occurs, please improve the ventilation conditions as soon as possible and reduce the ambient temperature.

Product Installation

Installation Environment -----

- ★ The refrigerator needs to be used indoors, with a pollution level of Class 2, and an overvoltage level of Class II.
- ★ Ambient temperature: 16°C to 32°C, recommended temperature: 18°C to 25°C. Air conditioning shall be used if necessary.
- ★ Ambient humidity: below 80%Rh.
- ★ Avoid exposure to large amounts of dust.
- ★ Avoid mechanical swinging or vibration.
- ★ Altitude of working position of refrigerator: below 2,000 m.
- ★ Input voltage: between (220-240V~) $\pm 10\%$
- ★ The refrigerator is sensitive to ambient temperature. If installed in an environment other than the above, the refrigerator may not operate properly. Please use it after improving the environment.
- ★ Do not install the refrigerator outdoors. Exposure to rain may cause an electric leakage or electric shock.

Installation Site -----

- ★ The refrigerator shall not be installed in a narrow and confined space. The space for installation shall allow the normal entry and exit of the equipment, without incurring maintenance difficulties in case of equipment failure, leading to delayed maintenance and damage to the stored items.
- ★ The ground for installation must be solid and flat, non-combustible and able to withstand the weight of the equipment during operation.
- ★ Good ventilation, no exposure to direct sunlight.
- ★ Each refrigerator shall be provided with an independent power socket. Please ensure that the power socket carries a current of ≥ 10 A and that the plug is firmly connected to the socket.
- ★ Check the working voltage before use. A voltage regulator suitable for the equipment load shall be considered for use in areas with unstable voltage. The voltage regulator power shall be more than 4,000 W to ensure that the input voltage requirements in the installation environment are met.
- ★ The equipment shall be grounded securely. If the power cord socket is equipped with a grounding wire, check that the grounding is good before use. If the socket is not equipped with a grounding wire, be sure to have a professional engineer install the grounding wire.



- ★ Do not connect the grounding wire to a gas pipe, water pipe, telephone line, or lightning rod when grounding the refrigerator; otherwise, an electric shock may occur.
- ★ The power plug must be accessible after installation to facilitate timely unplugging of the power cord in case of an emergency. Do not block the vent of the refrigerator.



- ★ Since the ambient temperature has a large impact on the equipment, the equipment may not operate normally if the above environmental requirements cannot be met. Please improve the environment before using the equipment, and please note that the equipment has an intermittent operation system.
- ★ Ambient temperature for storage and transportation: $-40^{\circ}\text{C}\sim+60^{\circ}\text{C}$, relative humidity: 10%~90%

Preparations before Use -----

1. Remove all outer packaging of the product (including protective foam in the packing box).
2. Count the accompanying accessories. Check the items in the box against the contents of the packing list. If there is any discrepancy, please contact after-sales service personnel in time.
3. Installation condition: Leave a gap of at least 10 cm around the refrigerator to facilitate ventilation and heat dissipation.
4. Adjust the feet to ensure that the refrigerator does not move during operation.
5. Install the door handle, take out the accessory bag, handle and screws, fix the handle at the mounting hole on the side of the door with a screwdriver or electric screwdriver, and cover the screw cover.

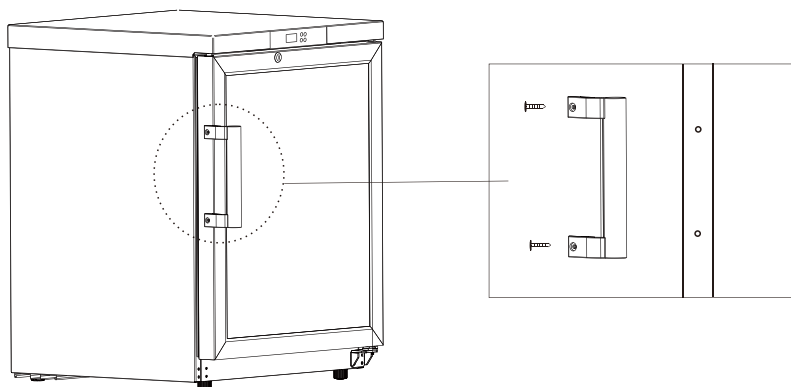

- ★ Place the plastic packing bag in a place not accessible to children to avoid suffocation accidents.

First Powering-On -----

Follow the steps below when using the equipment for the first time:

1. After the equipment is placed, leveled and cleaned, it shall be left for more than 24 hours before it is powered on to ensure normal operation.
2. Connect the power cord to a dedicated socket of appropriate specifications under no-load conditions.
3. After that, turn on the power switch and the lamp switch to ensure the normal operation of the lamp in the refrigerator.
4. Check whether the operating temperature of the equipment reaches the required value. After confirming the normal performance of the equipment after more than 24 hours of normal start/stop, place a small number of items in the cabinet.
5. Put items in batches, not exceeding 1/3 of the refrigerator volume at a time. The next batch of items can only be put in if the equipment is turned off and then turned on and off normally for more than 12 hours.
6. Avoid opening the door during the cooling process whenever possible; otherwise, the temperature may rise.

Operation after Powering-Off -----

The equipment can memorize the set values. When power is restored after a power outage, the equipment will continue the operation before the power outage.



Warning

- ★ Once the power is cut off, the refrigerator can only be re-energized after more than five minutes to avoid damage to the compressor or the system.
 - ★ When the refrigerator is going to be left unused for a long time, unplug the power plug and turn off the battery switch (applicable to refrigerators with batteries) to prevent electric shocks, electric leakages, or fire due to aging of the power cord.
 - ★ If the refrigerator is going to be left unused in an unsupervised area for a long time, ensure that children do not have access to the refrigerator and its door is not closed completely.
- A specially-assigned person shall check the product and record its condition every day. If there is an excessively high or low temperature in the refrigerator, the items shall be transferred to other refrigerators until the fault is removed; after that, the items can be transferred back.

- This product is a medical refrigerator with a temperature range of 2~8°C. Please confirm that the environment in the refrigerator is suitable for the stored items to avoid damage to the items and economic losses.
 - Due to the inertia of refrigeration, the temperature and humidity displayed on this product may differ from the actual temperature and humidity inside the refrigerator, which is normal.
 - Do not place items between the bottom of the liner and the bottom shelf of the refrigerator, so as not to block the air ducts.
- ⊘
- As all refrigerators are storage equipment, it is strictly prohibited to put in too many relatively hot items at one time, which will cause the compressor to work continuously for a long time, cause the temperature to drop slowly, and affect the service life of the compressor. The items must be put in batches to allow the temperature to decrease by steps until the required temperature is reached.
 - Do not damage the refrigeration circuit.
 - Do not use electrical appliances without production permits inside the refrigerator.

Product Components and Overview

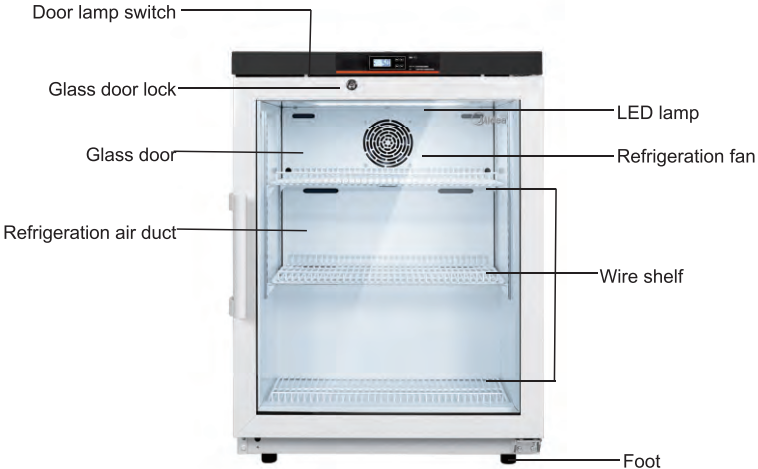

Schematic Diagram VS-5L126

Due to product improvement and differences among models, the actual product may be different from the diagram. Please refer to the actual product!
 The diagram is only for the description of functional parts.





Operating Instructions

Operation and Display Panel



Instructions

Button Symbol	Function
SET	SET button: In the unlocked status, press and hold it for 3s to display the current set point of control temperature St; in the setting status, press and hold it for 3s to save and exit;
▲	UP button, to switch between parameters or increase the parameter value;
▼	DOWN button, to switch between parameters or decrease the parameter value;
SET+FN	Press and hold it for 3s to unlock the locked controller or lock the controller;
SET+▲	Press and hold it for 3s to enter the setting interface of general menu parameters;
Press and hold ▲+▼ for 3s	Enter the time setting interface of the recorder;
Press and hold ▲ for 3s	Export data to USB flash drive; (optional USB)

Display Symbol	Meaning
	Refrigeration symbol flashing: refrigeration ON delay;
	Refrigeration symbol normally on: The compressor is started and refrigeration begins;
	Power supply symbol normally on: The external power supply of the controller is connected;
	Lock symbol normally on: The controller is locked;
	Alarm symbol flashing: The controller is in alarm status;
	Defrost symbol flashing: defrosting and dripping time;
	Defrost symbol normally on: The controller is in defrosting status;

Controller Parameters and Operation

The controller displays and controls the temperature measured by the cabinet temperature sensor under normal conditions, and displays "E01" when the cabinet temperature sensor fails.

Control Temperature Setting

In the unlocked status, press the SET button for more than 3s, and the display screen will display the current control temperature set point St; press the button ▲ or ▼ to increase or decrease the value, and press the SET button for more than 3s to confirm the parameter value. If there is any parameter change, the parameter value will flash for 2s, and then the system will store the modified parameter value and exit the interface; otherwise, it will exit directly.

Setting of General Menu Parameters

- In the normal operation status, after unlocking, press SET + ▲ at the same time for more than 3s, and the display screen will display the parameter code "H";
- Scroll through parameters (H, L, Mod) with buttons ▲ and ▼;
- Press the SET button to confirm the parameter, and the parameter value is displayed;
- Increase or decrease the parameter value with buttons ▲ or ▼;

- e. Press SET button to temporarily store the modified parameter value and return to the displayed parameter;
- f. To modify other parameter values, repeat steps b~e;
- g. Press the SET button for more than 3s to store the modified parameter value and exit the parameter setting program.

Time Setting (Optional USB)

In the normal operation status, after unlocking, press the UP + DOWN buttons at the same time for 3s to enter the time setting interface;

If there is an abnormality in the USB data recorder, the characters "nDR" will be displayed for prompting; otherwise, the character "yer" will be displayed. Switch between "yer", "mth", "day", "HH" and "MM" by pressing the UP and DOWN buttons. Press the SET button to set the corresponding time, and press and hold the SET button for 3s to save and exit. Leave buttons unoperated for 10s, the system will exit the interface without saving. When inserting or pulling out the USB flash drive, the controller will buzz for 0.5s.

Data Export (optional USB)

Manual: In the normal operation status, after unlocking, press and hold the UP button for 3s to enter the data export interface;

If the USB data recorder does not function properly, the characters "nDR" will be displayed; if the USB flash drive is not connected, the characters "nUS" will be displayed;

Press UP or DOWN button to select from M1~M12. Press and hold the SET button for 3s to confirm the data export. M1~M12 represents the 1~12 months ahead of the current time of data export. If the amount of data to be exported is large and the system keeps exporting data after it exits the operation interface, "ULD" will be displayed until the data export is completed. If there is no button operation for 3s, the system will exit the interface without saving.

Tips: Due to product improvement or contract agreement, the actual functional configuration of your refrigerator may be different from here. Please refer to the actual configuration.

Alarm Description

Code	Cause	Action
Err	Data access fault	None
E01	Cabinet temperature sensor fault	The alarm sign flashes, E01 is displayed, the buzzer sounds immediately, and the compressor is in proportional operation status.
E02	Display sensor fault	The alarm sign flashes, E02 is displayed, and the buzzer sounds immediately.
AH	High (H) temperature alarm	A H and temperature are alternately displayed, the alarm sign flashes, and the buzzer starts to sound after A2 time passes
AL	Low (L) temperature alarm	A L and temperature are alternately displayed, the alarm sign flashes, and the buzzer starts to sound after A2 time passes
dor	Door open or not closed tightly	The alarm sign flashes. After A3 time passes, dor and temperature are alternately displayed and buzzing starts.
None	Ambient temperature $\geq 35^{\circ}\text{C}$	The alarm symbol flashes; the cabinet temperature and the ambient temperature are displayed alternately
None	Power outage	The alarm symbol is displayed; the buzzer sounds intermittently for 2 min.; the temperature is displayed intermittently for 20h.

Maintenance



- ★ In order to prevent electric shocks or injuries, the power supply must be cut off before any repair and maintenance of the equipment.
- ★ Make sure that drugs or suspended particles from the surrounding environment will not be inhaled during equipment maintenance. Otherwise, they may cause harm to human health.



- ★ Do not spill water directly on the refrigerator body to avoid reduced insulation performance of electrical components and rusting of metal parts.
- ★ Do not use hot water and corrosive cleaners or organic solvents to clean the refrigerator body.
- ★ Do not put heavy objects on top of the equipment to avoid deformation of the equipment due to pressure.

Equipment Maintenance

Defrosting: The equipment will automatically defrost during operation, which is convenient.

Cleaning and Maintenance:

- 💧 The refrigerator should be cleaned once a month. Regular cleaning enables the refrigerator to remain in a newly-bought status.
- 💧 Wipe a small amount of dust off the refrigerator's housing, inner cabinet, and all accessories with a dry cloth. If the refrigerator is dirty, remove the dirt with a cleaning cloth soaked in neutral detergent and wipe off the residual detergent with a wet cloth, and then wipe the refrigerator with a dry cloth.
- 💧 Do not pour water onto the refrigerator housing or into the refrigerator. Otherwise, the electrical insulation may be damaged, leading to a failure.
- 💧 The compressor and other mechanical parts are completely sealed and do not require lubrication.

Equipment Left Unused

Unused: Cut off the power supply if the equipment is going to be left unused in an unsupervised area for a long time. Clean the inner and outer surfaces of the refrigerator with a warm and wet soft cloth, let it dry and then seal it. Be sure to lock the equipment to prevent children from opening the door and avoid accidents such as suffocation.

Scrapping: When the equipment reaches the end of its service life, it shall be scrapped. It must be handed over to a qualified professional recycling organization for disposal in accordance with local regulations and ordinances. Non-professional personnel shall not disassemble or dismantle the equipment without authorization. Scrapped equipment shall be placed in a designated area inaccessible to children to avoid danger.

Troubleshooting and Repair Service

When the product fails, please check and handle it against the following table first. If the problem cannot be solved, please inform the Service Center of Midea Biomedical in time, and we will do our best to help you and avoid any loss.

Fault	Troubleshooting Method
Refrigerator not working	Whether the input power supply meets the requirements
	Whether the plug and socket are in poor contact
	Whether the input and control lines are faulty
	Whether the voltage is too low
The refrigeration effect is not obvious and the temperature exceeds the standard value	Whether too many items are stored or the items are too hot
	Whether there is a certain clearance between the stored items
	Whether there is direct sunlight or other heat source radiation
	Whether the door is opened frequently
	Whether the ambient temperature is too high
Excessive noise	Whether the refrigerator is placed flatly
	Whether a part of the refrigerator body contacts external objects or the wall
	The difference between actual noise and marked value is normal during operation due to the influence of stored items, ambient noise, the door being not closed, compressor ON/OFF, etc.
The alarm lamp flashes and the buzzer sounds an alarm	Whether the temperature of the item just put in is not within 3~7°C. The alarm will be cleared after a period of operation.
	Whether the door open alarm sounds due to the door not being closed tightly. Re-close the door
	Whether the battery is low. The refrigerator will return to normal after having started for a period of time
	Whether the temperature exceeds the standard value

Specifications

Name	Medical Refrigerator
Model	VS150
External dimensions (W*D*H) (mm)	595*615*810
Internal dimensions (W*D*H) (mm)	505*467*620
Effective volume	126L
Door	Transparent glass door
Foaming agent	Cyclopentane
Shelf	Plastic-dipped steel wire shelf (3 pcs.)
Cooling mode	Air cooling cycle
Outer/inner plate	Painted steel plate/painted steel plate
Condenser/evaporator	Built-in/built-in
Temperature controller	Computer control system
Refrigerant	R600a
Lighting	LED lamp
Net weight	43kg
Rated power supply	220-240V~/50Hz
Rated power/current	100W/1.0A
Type of protection against electric shock	I
Power supply connection mode	Y

Packing List

Model	Instructions	Key	Accessory Bag	Steel Wire Shelf, including Mounting Clips	Handle and Accessory Bag
VS150	1	2	1	3	1

*Instructions include warranty card and certificate of conformity. The specific packing list shall be subject to the product received

Electrical Schematic Diagram

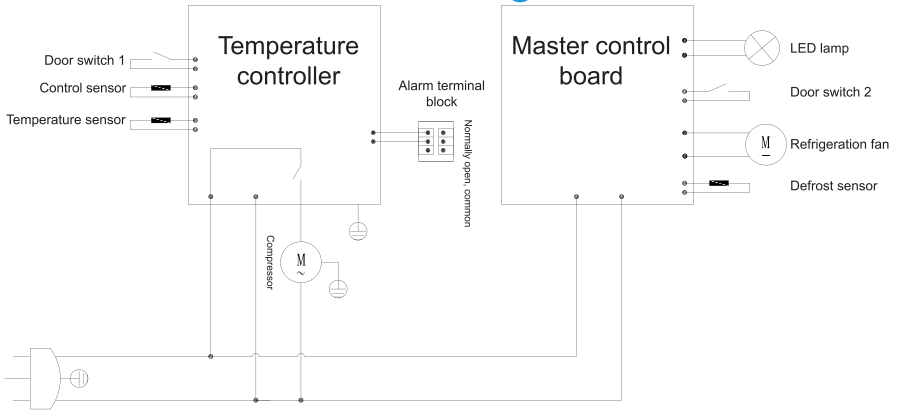

Operating capacitance is optional, depending on compressor selection

[VS-5L126 Electrical Schematic Diagram](#)