

Product implementation standards
 EN 61010-1 :2010/A1:2019
 EN 61010-2-011:2017
 EN 61326-1 :2013

EN

USER MANUAL

Vacc-Safe

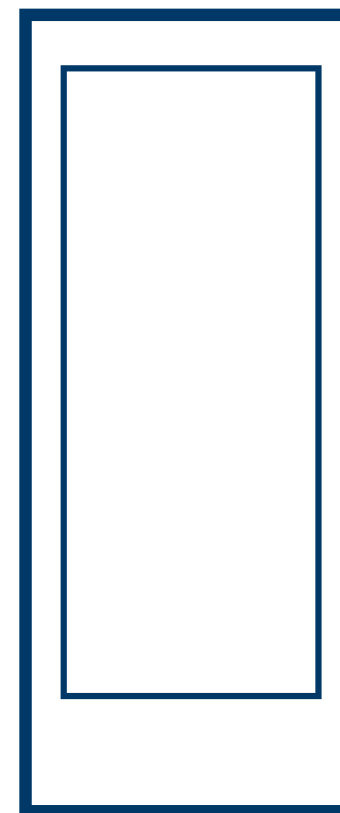

Vacc-Safe



Warning:
 Before using this product,
 please read this manual carefully
 and keep it for future reference.
 The design and specifications
 are subject to change without
 prior notice for product
 improvement. Consult with your
 dealer or manufacturer for
 details.

version:001-7-2022

MODEL: VS-25L308
VS-40L308
VS-25L106
VS-40L106

Contents

1. Product Features	01
2. Safety Precautions	02
3. Precautions for Use	06
4. Product Installation	07
5. Product Components and Overview	10
6. Operating Instructions	13
7. Alarm Description	16
8. Maintenance	17
9. Troubleshooting and Repair Service	19
10. Specification	20
11. Packing List	21
12. Electrical Schematic Diagram.....	22

Product Features

This product is mainly intended to keep drugs, vaccines, and reagents. It is applicable to hospitals, epidemic prevention stations, universities, scientific research institutes and electronic chemical industry enterprise labs.

Product Functions

Accurate Temperature Control

Data Traceability

- ⑤ Computer temperature control, with a display accuracy of 0.1°C
- ⑤ The temperature in the biomedical freezer is uniform and controllable, the temperature range is adjustable to -25°C (VS-25L308)/-40°C (VS-40L308), and the temperature control is accurate
- ⑤ Standard USB port and traceable temperature data; query and save temperature data at any time

Efficient Refrigeration

Effective Thermal Insulation

- ⑤ Famous brand compressor and optimized refrigeration system provide strong refrigeration capacity, safety and reliability
- ⑤ High-performance thermal insulation layer has the good thermal insulation effect
- ⑤ Multi-layer 3D seal design effectively reduces refrigerating capacity loss and frosting

Multiple Alarms

Safety and Stability

- ⑤ Perfect acoustic and optical alarm function, allowing high- and low-temperature alarms, power off alarm, sensor fault alarm, etc. with alarm values adjustable on demand
- ⑤ Design of safety door lock improves the safety level of sample management

Ergonomics Design

- ⑤ It can display the temperature inside the biomedical freezer and ambient temperature, and allows setting the high and low temperature alarm values and the biomedical freezer temperature values as required, with the function of fault warning and early warning.
- ⑤ Remote alarm function ensures real-time controllability and safe and stable operation of the equipment.

Note: The above features are not available for all models of products, and the detailed configuration shall be subject to the specific functions of each model. Due to the continuous optimization of the product, the product you obtained may not be exactly consistent with the instructions. We sincerely apologize for this.

Safety Precautions

Dear Vacc-Safe users:

We appreciate your trust. Thank you for using Vacc-Safe biomedical freezer. Please carefully read the following information to better understand the Operating Instructions and use this product, so as to prevent personal injury and damage to items.

Safety warning signs



Warning



Warning hands pinching!



Electrocution hazard!



Combustible material!

Safety Precautions



Document review is required in all cases marked with  to clarify the nature of potential hazards and the countermeasures that must be taken.



Ignoring WARNING items may result in serious casualties.



Ignoring CAUTION items may result in casualties or damage to the biomedical freezer and related properties.



Acts or operations that must be prohibited



Actions or operations that must be followed



Please use a power socket with a grounding wire to prevent electric shock. If the power socket is not grounded, the grounding wire must be installed by professional technicians.



This biomedical freezer must be firmly placed on a solid and flat ground and proper care is taken to prevent overturning. If the floor is not level or the biomedical freezer is placed in an improper location, the biomedical freezer may fall down and cause injuries.



If the power cord needs to be extended, the cross-sectional area of the extension cord shall not be less than 2.5mm² and the length shall not be longer than 3m. Otherwise, it may cause fire or electric shock.



In case of leakage of gas and other flammable gases, close the valve with gas leakage, and open the doors and windows to ventilate and exhaust gas. Do not plug or unplug the power plug of the biomedical freezer, otherwise it may cause an explosion and fire.



Only professional technicians or maintenance personnel for after-sales support can disassemble and assemble the biomedical freezer. Otherwise, it may electric shocked to cause a fire.



Please use the special power supply indicated on the nameplate of the biomedical freezer, otherwise it may cause a fire or electric shock.



If the applied voltage is lower than 198V or higher than 242V, an automatic voltage stabilizer of more than 4000W suitable for motor load needs to be installed for assistance.



The power cord of this biomedical freezer is equipped with a three-prong (grounded) plug to mate with a standard three-prong (grounded) outlet of 10A. Do not cut or remove the grounding pin of the power cord under any circumstances. Make sure that the power plug and the outlet are connected firmly and reliably, otherwise it may cause a fire.



When the plug is removed from the power socket, it shall be held tightly, and the wire of the plug shall not be pulled. If the wire is pulled, electric shock or fire due to a short circuit may be caused.



If the biomedical freezer is not operating properly, unplug the power plug. Continued operation under abnormal conditions may cause electric shock or fire.



Before any repair or maintenance of the biomedical freezer, always disconnect the biomedical freezer from the power supply to prevent electric shocks or personal injuries.



Make sure that the drugs or suspended particles inside and around the biomedical freezer will not be inhaled during repairs and maintenance, otherwise it may cause harm to human health.



When storing toxic, harmful, or radioactive substances, please use the biomedical freezer in a safe area. Improper use may cause harm to health or the environment.

















Disconnect the power plug when the biomedical freezer is not in use for a long period, so as to prevent electric shock, electric leakage, or fire due to the deterioration of the power cord.

















If the biomedical freezer is to be stored unused in an unsupervised area for a long period, ensure that children do not have access to the biomedical freezer. The disposal of the biomedical freezer shall be accomplished by the appropriate personnel. Doors shall be removed to prevent accidents such as suffocation.



If CO₂/LN₂ standby system is used, a good ventilation environment must be provided at the installation and use site. Increased carbon dioxide concentrations in the air can asphyxiate and endanger life safety. In case of poor ventilation, other methods must be considered to ensure a safe environment.

-  Never store corrosive substances such as acids or alkalis in the biomedical freezer. Otherwise, these substances may cause damage to internal components or electrical parts of the biomedical freezer.
-  Never store flammable, explosive, or volatile substances in the biomedical freezer or use flammable sprays near the biomedical freezer, otherwise it may cause an explosion or fire.
-  Do not leave the plastic packing bags in a place where they can be reached by small children as this may result in suffocation accidents.
-  Do not climb on the biomedical freezer or put any objects on the biomedical freezer, otherwise the biomedical freezer may fall and cause injuries or cause damage to the biomedical freezer.
-  Do not use the biomedical freezer outdoors. Exposure to rain may cause an electric leakage or electric shock.
-  Do not place the biomedical freezer in a humid location or a place where the biomedical freezer is easy to be splashed with water. Otherwise, electric leakage or electric shock will be caused due to degradation of insulation.
-  Do not pour water directly onto the biomedical freezer, otherwise it may cause an electric shock or a short circuit.
-  Never disassemble, repair, or modify the biomedical freezer yourself. Otherwise, it may cause fire or personal injury due to improper operation.
-  Do not connect the grounding wire to a gas pipe, power supply pipe, telephone line, or lightning rod when grounding the biomedical freezer. The above grounding may cause electric shock or other hazards.
-  Do not touch any electrical parts such as the power plug or operate any switch with a wet hand, otherwise, it may cause an electric shock.
-  Do not put water containers or heavy objects on the biomedical freezer. Falling objects may cause personal injuries, and spilled water may cause degradation of insulation, resulting in an electric leakage or electric shock.
-  Never insert metal objects such as iron nails and wires into any vent, gap, or air outlet on the biomedical freezer. This may cause electric shocks or injuries by accidental contact of these objects with moving parts.
-  It is not allowed to tie, drag, pull, wind and bind the power cord, or damage the power cord plug. Damaged power cords or plugs may cause fire or electric shock.
-  The power cord with a loose plug is not allowed, because it may cause fire or electric shock.
-  It is not allowed to put glass bottles or canned items in the biomedical freezer, which may be frozen and cracked, causing injury to personnel.

 CAUTION

-  Keep the biomedical freezer clear of obstruction around it to ensure smooth ventilation.
-  When it needs to restart the biomedical freezer after the biomedical freezer is unplugged or the power to the biomedical freezer is interrupted, check the settings of the biomedical freezer. Changes in settings may deteriorate the stored items.
-  If the biomedical freezer is unplugged or the power to the biomedical freezer is interrupted, do not restart the biomedical freezer for at least 5 minutes to avoid damage to the compressor or system.
-  The filter screen shall be checked in time and cleaned. Dust-laden filter screens can cause temperature rise or failure in the biomedical freezer.
-  If the power plug has dust, it needs to be cleaned in time. Improper connection or plug filled with dust may cause heating or ignition.
-  After the power is cut off or the power switch is off, the setpoint shall be checked when the power switch is restarted; otherwise, the stored items may be damaged due to setting change.
-  Wear gloves during maintenance to avoid personal injuries caused by touching sharp edges or corners.
-  The stored items shall not be contacted directly by hand. Direct contact with the frozen items or the inner wall of the biomedical freezer may cause frostbite.
-  Hold the handle to close the chamber door, so that the door does not pinch fingers.
-  Tilt the biomedical freezer for 30° when handling or moving it.
-  Be careful not to trip over the biomedical freezer when handling the biomedical freezer, so as to prevent damage to the biomedical freezer or personnel injuries.
-  Do not use door handles to lift or carry equipment to prevent damage to the biomedical freezer or personnel injuries.
-  Do not damage the refrigeration circuit.
-  Do not use electrical appliances inside the storage compartment of the biomedical freezer, unless they are of the type recommended by the manufacturer.

Precautions for Use

- + When the biomedical freezer is running, the left and right rear sides of the biomedical freezer may be heated, which is not a fault. In order to prevent condensation around the biomedical freezer housing, the condensate pipe is installed.
- + Before putting items into the equipment, confirm that the temperature in the storage chamber has reached the set temperature, and then put the items in batches. Do not put in items for more than 1/3 of the volume of the chamber at a time to prevent its temperature from rising too much.
- + The equipment temperature display is the temperature at the temperature sensor in the storage chamber. When the equipment is initially running, the displayed temperature is somewhat different from the actual temperature at the center of the equipment. However, as the equipment enters a stable state, the displayed temperature will gradually approach the actual temperature.
- + The equipment chamber is designed with a testing hole so that the test line inside the chamber can be led out for test. After the testing line is pulled out, it is necessary to plug the testing hole again with thermal insulation material, otherwise the temperature in the biomedical freezer may not reach the set temperature and cause condensation around the outside of the hole (applicable to biomedical freezers with testing holes).
- + Please use diluted neutral cleaner to clean the equipment. Do not use brushes, acid, gasoline, soap powder, polish or hot water to clean this equipment, otherwise it may damage the painted surface and plastic rubber parts. Special care must be taken not to use volatile solvents such as gasoline to wipe plastic and rubber parts.
- + When the biomedical freezer is not in use for a long period, cut off the power supply and turn off the battery switch.
- + If the biomedical freezer is not started again for a long time, a low battery level may occur. After the battery switch is placed at "ON", the battery can be charged, and the biomedical freezer can run continuously for about one week to charge the battery (applicable to models with batteries).
- + Please minimize the time of opening the door during each access to the items, so as not to cause great fluctuations in the temperature and humidity in the biomedical freezer.
- + After the door is opened, the temperature in the biomedical freezer will rise sharply in a short time, which is normal, and it will return to set temperature of normal operation after the door is closed.
- + After the biomedical freezer has been running for a period of time, a layer of frost is formed on the inner wall and evaporator of the biomedical freezer. If the frost layer is too thick, it will affect the thermal insulation effect of the biomedical freezer and increase the power consumption. Therefore, after the frost layer reaches 5 mm, the attached shovel shall be used to defrost.
- + Before defrosting, the frozen items in the biomedical freezer shall be taken out and placed in an environment suitable for storage, so as not to damage the items due to temperature rise in the biomedical freezer.
- + There are many refrigerating coils in the biomedical freezer. The frost from the inner wall shall not be removed by sharp tools such as knife, ice chisel or screwdriver. The inner wall shall not be scratched during defrosting, or the biomedical freezer will fail.

Product Installation

Installation Environment

- + Ambient temperature: 10 °C~32 °C; ideal temperature: 18 °C~25 °C; air conditioning system shall be used if necessary.
- + Ambient humidity: below 80% RH. The humidity shall be less than 60% Rh if the maximum operating temperature is 32 °C.
- + Avoid large amounts of dust.
- + Avoid mechanical rocking or vibration.
- + Altitude of working position of biomedical freezer: lower than 2000m.
- + Input voltage: within 220V±10%.
- + The biomedical freezer is sensitive to ambient temperature. If installed in an environment other than the above, the biomedical freezer cannot operate normally. Please use it after improving the environment.
- + Do not install the biomedical freezer outdoors. Exposure to rain may cause an electric leakage or electric shock.

Installation Site

- + It shall not be installed in a narrow and closed space. The door body of the room where the biomedical freezer is placed shall not be smaller than or lower than the biomedical freezer, or at least the normal access of the equipment shall be ensured, so as to avoid maintenance difficulties in the event of equipment failure and causing damage to the stored items due to failure of repairing the equipment in time.
- + The ground for installation must be solid and flat, non-combustible and able to withstand the weight of the equipment during operation.
- + Good ventilation, no direct sunlight.
- + Each refrigerator-freezer shall be provided with an independent power socket. Please ensure that the power socket shall carry a current of ≥ 10A and the plug shall be firmly connected to the socket. The power cord shall not be twisted or pressed.
- + Check the working voltage before use. A voltage stabilizer suitable for the equipment load shall be considered for use in areas with unstable voltage. The voltage stabilizer power shall be more than 4000W to ensure that the input voltage requirements in the installation environment are met.
- + The equipment shall be grounded securely. If the power cord socket is equipped with a grounding wire, check that the grounding is good before use. If the socket is not equipped with a grounding wire, be sure to have a professional engineer install the grounding wire.



- + Do not connect the grounding wire to a gas pipe, water pipe, telephone line, or lightning rod when grounding the biomedical freezer, otherwise it may cause an electric shock.
- + The power plug must be accessible after installation to facilitate timely unplugging of the power cord in case of emergency. Do not block the vent of the biomedical freezer.



- Since the ambient temperature has a large impact on the equipment, the equipment may not operate normally if the above environmental requirements cannot be met. Please improve the environment before using the equipment. The equipment has an intermittent operation working system.

Preparations before Use

1. Remove all transport packaging materials and belts.
2. Counting the accompanying accessories. Check the items in the box against the contents of the packing list. If there is any discrepancy, please contact with after-sales service in time.
3. The placement conditions shall be such that clearances of at least 30cm are reserved around the biomedical freezer for ventilation and heat dissipation.
4. Rotate the horizontal supporting feet clockwise with a wrench or manually to extend downward so that they are supported on the ground to ensure that the biomedical freezer does not move when used.
5. Take out the back bracket in the biomedical freezer, and fix the back bracket on the back plate with screws.
6. Take out the handle, align the handle with the hole on the right side of the door, fix the door handle to the door with an electric screwdriver, and then fasten the handle trim cover to the upper and lower ends of the handle.



- Place the plastic packing bags in a place not accessible to children to avoid suffocation accidents.

First Power-up

Follow the steps below when using the equipment for the first time:

1. After the equipment is placed and leveled and cleaned, it shall be left for more than 24 hours before it is powered on to ensure normal operation.
2. Connect the power cord to a dedicated socket of suitable specification under no-load condition.
3. After the power supply is turned on, turn on the power switch of the equipment first; if the equipment is equipped with a battery, turn on the battery switch again.
4. Set the required temperature, do not put anything in the empty biomedical freezer, power on and start up, check whether the operating temperature of the equipment reaches the required temperature, observe the normal startup and shutdown of the equipment for more than 24 hours, and demonstrate that the performance of the biomedical freezer is normal.
5. Store items in batches, not exceeding 1/3 of the chamber volume at a time. Ensure that the equipment is shut down and operates normally after being switched on and off for more than 8 hours before placing the next batch of items.
6. Avoid opening the door during the cooling process as much as possible, otherwise it will cause the temperature to rise.

Operation after Power-off

The set value is memorized by the equipment. After recovery from a power failure, the equipment will resume operation with the setting parameters before the power failure.



- If the biomedical freezer is unplugged or the power to the biomedical freezer is interrupted, do not restart the biomedical freezer for at least 5 minutes to avoid damage to the compressor or system.



- When the biomedical freezer is not in use for a long period, unplug the power plug and turn off the battery switch (applicable to biomedical freezers with batteries) to prevent electric shock, electric leakage, or fire due to the deterioration of the power cord.
- If the biomedical freezer is to be stored unused in an unsupervised area for a long period, ensure that children do not have access to the biomedical freezer and that doors cannot be closed completely.



- The product shall be managed by a specially-assigned person to check the operation and make records every day (it is recommended to record the inspection once every 2~4 hours). In case of failure or shutdown, the temperature in the biomedical freezer will rise. If it cannot be repaired in a short time, the articles shall be transferred to other places that meet the temperature requirements for storage to avoid damage to the articles.
- This product is a biomedical freezer. Please confirm in advance that the temperature required for the stored articles is consistent with the temperature range of the biomedical freezer to avoid damage to the stored articles due to mismatch of the temperature range.
- Due to the inertia of refrigeration, the temperature and humidity displayed for this product may differ from the actual temperature and humidity inside the chamber, which is a normal phenomenon.



- Since all biomedical freezers are storage equipment, it is strictly prohibited to put too many relatively hot items at one time, which will cause the compressor to not stop for a long time, the temperature will drop slowly and affect the service life of the compressor. The items must be put in batches to allow the temperature to decrease by steps until the required temperature is reached!
- Do not damage the refrigeration circuit.
- Do not use electrical appliances without production permits inside the biomedical freezer.
- No mechanical tools or other means without the manufacturer's permission shall be used to accelerate the defrosting process.

Product Components and Overview

Schematic Diagram of Appearance

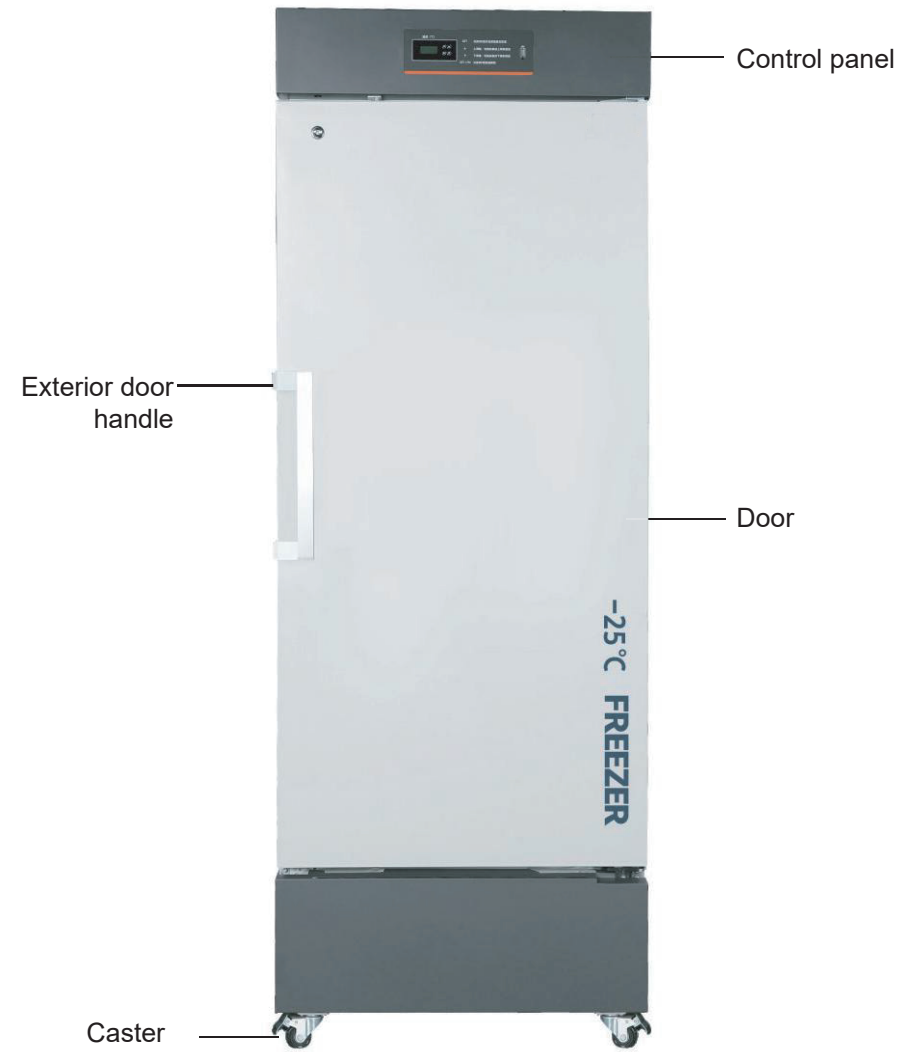
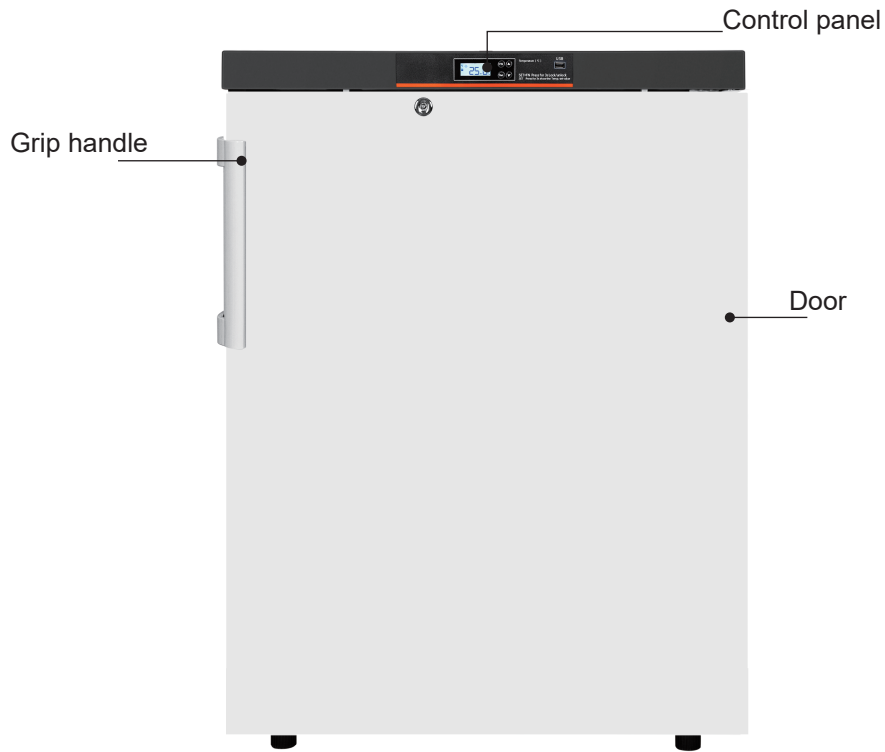

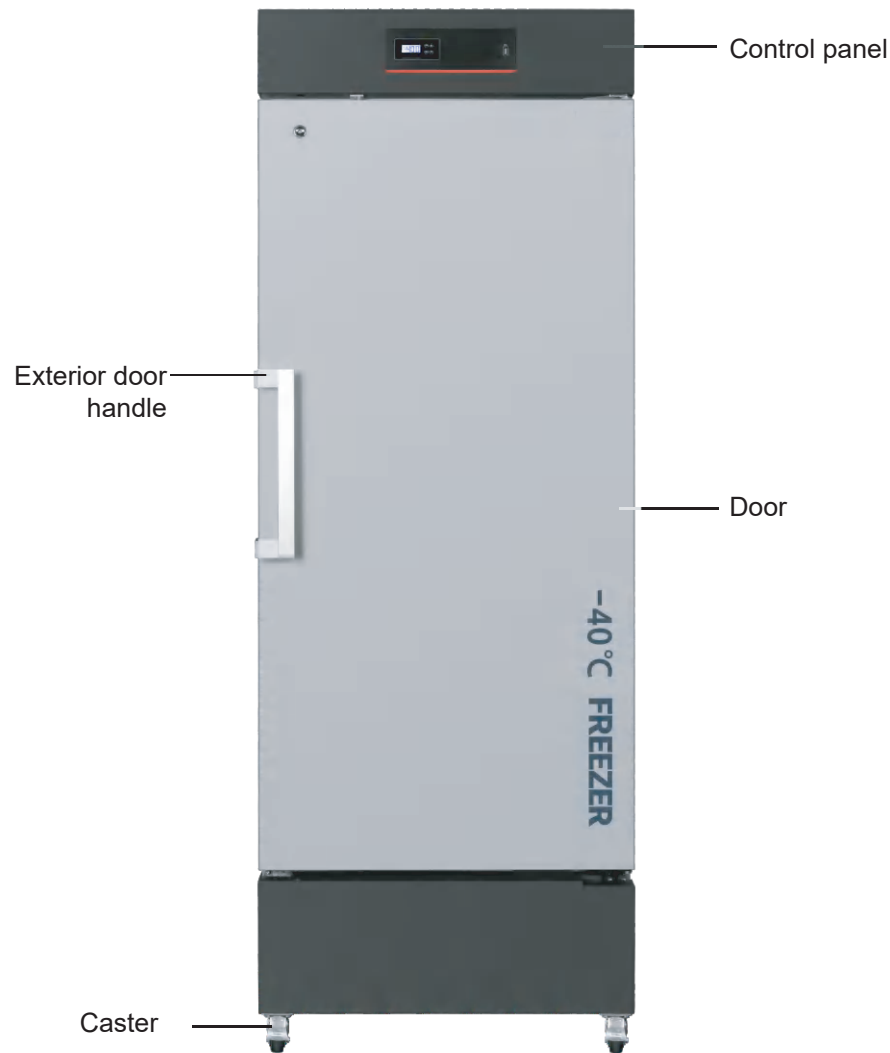

Operating Instructions

Display Panel

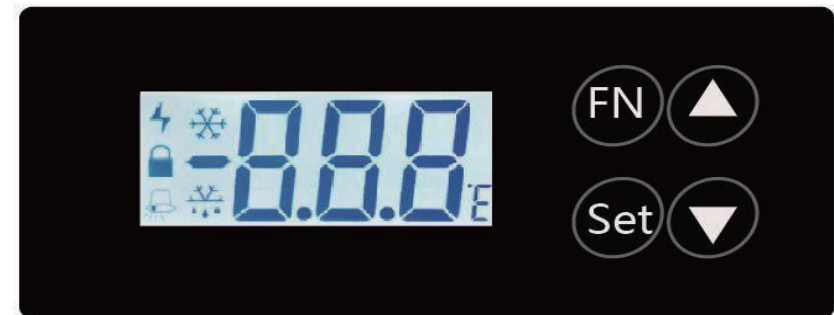





Operating Instructions

Key Symbol	Function
FN	Press and hold the FN key for 3s under unlocking state to enter the maintenance mode;
SET	SET key: In the unlocking state, press and hold the SET key for 3s to display the current control temperature set value St: in the setting state, press and hold the key for 3s to save and exit;
▲	Up key to switch parameters or adjust up parameter values;
▼	Down key to switch parameters or adjust down parameter values;
SET+FN	Press and hold for 3s to unlock or lock the controller;
SET+▲	Press and hold for 3s to enter the setting interface of general menu parameters;
SET+▼	Press and hold for 3s to manage the parameter setting of the menu;
Press and hold ▲+▼ for 3s	Enter the time setting interface of the recorder;
Press and hold ▲ for 3s	Export data to USB flash disk;
Press and hold ▼ for 3s	Print data;

Due to the improvement of the product and different models, the actual product may be different from the schematic diagrams. The actual configuration will depend on the physical product.

The schematic diagrams are only for brief description of functional parts.

Display Symbol	Meaning
	Refrigeration symbol flashing: refrigeration on delay;
	Refrigeration symbol normally on: the compressor is started and refrigeration begins;
	Power symbol normally on: the external power supply of the controller is connected;
	Lock symbol normally on: the controller is locked;
	Alarm symbol flashing: the controller is in alarm state;
	Defrost symbol flashing: defrosting dripping time;
	Defrost symbol normally on: the controller is in defrosting state;

Controller Parameters and Operation

Under normal conditions, the controller displays and controls the biomedical freezer temperature measured. When the biomedical freezer temperature sensor fails, it displays "E01". When the biomedical freezer temperature is higher than 85°C, it displays "EHi". When the biomedical freezer temperature is lower than -50°C, it displays "ELo".

Control Temperature Setting

In the unlocking state, press the SET key for more than 3s, and the display screen will display the current control temperature set value St; press the ▲ key or ▼ key to increase or decrease the value, and press the SET key for more than 3s to confirm the parameter value. If there is any parameter change, it will flash for 2s, and then store the modified parameter value and exit; otherwise, it will exit directly.

Setting of General Menu Parameters

- In the normal operation state, after unlocking, press SET key + ▲ key for more than 3s at the same time, and the LCD display screen will display the parameter code "AH";
- Scroll parameters (AH, AL, abc) with ▲ key and ▼ key;
- Press the SET key to confirm the parameter, and the value of this parameter is displayed;
- Increase or decrease the value of the parameter with ▲ key or ▼ key;
- Press SET key to temporarily store the modified parameter value and return to the display parameter;
- If the values of other parameters are modified, repeat steps b~e;
- Press the SET key for more than 3s to store the modified parameter value and exit the parameter setting program.

Management of Menu Parameter Setting

- In the normal operation state, after unlocking, press SET key + ▼ key for more than 3s at the same time, and the LCD display screen will display the parameter code "PAS";
- Press SET key to enter password setting;
- Scroll the number to "-15" with ▲ key and ▼ key;
- Press the SET key to confirm the password. If the password is incorrect, the parameter setting program will exit;
- Scroll the parameter names with ▲ key and ▼ key;
- Press SET key to display corresponding parameter values;
- Increase or decrease the value of the number with ▲ key or ▼ key;
- Press SET key to temporarily store the modified parameter value and return to the display parameter;
- Repeat e~h if the values of other parameters are modified;
- Press the SET key for more than 3s to store the modified parameter value and exit the parameter setting program.

Note: If there is no key operation within 10s, the controller will automatically exit the parameter setting state (parameters are not saved) and return to the operation state. If there is no key operation for 3 minutes, the controller will be locked and the buzzer will buzz for 0.5s.

Press SET and FN for 3s at the same time to unlock or lock the locked controller, and the buzzer will buzz for 0.5 s. When the controller is locked, it cannot be operated. It can only be operated after unlocking;

Time Setting

The display shows "yer". At this time, the parameters "yer"/"mtH"/"day"/"HH"/"MM" can be selected through the up and down keys, representing year/month/day/hour/minute respectively. After selecting the parameter to be set, press "set" to adjust the parameter. After adjustment, press and hold "set" for 3s to save and exit. During parameter adjustment, if there is no key operation within 10s, the setting will be exited directly, and all adjusted parameters will not be saved. The main control panel will buzz for 0.5s when the USB board is inserted, and the USB flash disk is inserted and pulled out.

If the recorder DR3180 is not connected or DR380 is abnormal, the display shows the character 'nDR' and the time cannot be set.

Export Data

Manual: Under normal operation state, after unlocking, press and hold the up key for 3s to enter the data export interface;

If the recorder DR830 is not connected, the character "nDR" will be displayed; if the USB flash disk is not connected, the character "nUS" will be displayed; Press up and down key to select M1~M12. Press and hold SET key for 3s to confirm the data export. M1~M12 represents the current time of data export, which is pushed forward by 1~12 months. If there are many data exported and the operation interface exits and the data is still being exported, "ULD" will be displayed at this time until the data export is completed. If there is no key operation for 3s, the interface will exit without saving.

Manual Data Printing (Reserved)

Manual: Under normal operation state, after unlocking, press and hold the down key for 3s to enter the data print interface;

Select dt1~dt7 by pressing the up and down keys, and press and hold the SET key for 3s to confirm the printing. Dt1~dt7 represents the current printing time, which is pushed forward for 1~7 days. If there is no key operation for 10s, the interface will exit without saving.

Warehousing Mode

- In the power-off operation state, after unlocking, press SET key + ▼ key for more than 3s at the same time, and the LCD display screen will display the parameter code "PAS";
- Press SET key to enter password setting;
- Scroll the number to "22" with ▲ key and ▼ key;
- Press the SET key to confirm the password. If the password is incorrect, the warehousing mode setting program will exit;
- If the password is correct, it will enter the warehousing mode and the power supply of the temperature controller will be turned off;
- The above actions shall be completed during the buzzer alarm period (about 2 minutes) after power failure;

After entering the warehousing mode, the current consumption of the whole temperature controller is lower than 5uA.

Alarm Description

Code	Cause	Action
Err	Data access fault	N/A
E01	Biomedical freezer temperature sensor fault	The alarm symbol flashes; E01 is displayed; buzzer sounds immediately; compressor is in proportional operation; remote alarm is disconnected in mode C.
E02	Ambient temperature sensor fault	The biomedical freezer temperature sensor fails in A mode; there is no alarm in B mode and C mode;
AH	AH high temperature alarm	AH and temperature are displayed alternately; the alarm symbol flashes; the buzzer buzzes when A2 is exceeded; the remote alarm is disconnected in mode C.
AL	AL low temperature alarm	AL and temperature are displayed alternately; the alarm symbol flashes; the buzzer buzzes when A2 is exceeded; the remote alarm is disconnected in mode C.
EHi	Sensor temperature > 85°C	EHi and temperature are displayed alternately; the alarm symbol flashes.
ELo	< -50°C	ELo and temperature are displayed alternately; the alarm symbol flashes.
dor	Door open or not closed	The alarm symbol flashes; when A3 is exceeded, dor and temperature are displayed alternately and the buzzer buzzes; the remote alarm is disconnected in mode C.
N/A	Ambient temperature ≥ 35°C	The alarm symbol flashes; the biomedical freezer temperature and ambient temperature are displayed alternately.
N/A	Power-off	The alarm symbol is displayed; the buzzer sounds intermittently for 2 min.; the temperature is displayed intermittently for 20 h.

Maintenance



WARNING

- + In order to prevent electric shock or injury, the power supply must be cut off before any repair and maintenance of the equipment.
- + Make sure that drugs or suspended particles from the surrounding environment will not be inhaled during equipment maintenance. Otherwise it may cause harm to human health.



CAUTION

- + Do not spill water directly on the chamber body, so as not to cause the electrical components insulation performance decline and metal parts rust.
- + Do not use hot water and corrosive cleaners or organic solvents to clean the chamber body.
- + Do not put heavy objects on top of the equipment to avoid deformation of the equipment under pressure.

Cleaning of Biomedical Freezer

- ▷ The biomedical freezer should be cleaned once a month. Regular cleaning keeps the biomedical freezer a brand-new appearance.
- ▷ Wipe the dust off the biomedical freezer's shell, inner chamber, and all accessories with a dry cloth. If the biomedical freezer is dirty, wipe it with a cleaning cloth soaked with a neutral detergent to remove the dirt and wipe off the residual detergent with a wet cloth. Then, wipe it with a dry cloth again.
- ▷ Do not pour water onto the biomedical freezer shell or into the biomedical freezer. Otherwise, it may damage the electrical insulation, leading to a failure.
- ▷ The compressor and other mechanical parts are completely sealed and do not require lubrication.
- ▷ Clean the frost or ice on the inner wall and the condenser filter screen once a month.

Defrosting Inside Biomedical Freezer

Frosting may cause a gap between the biomedical freezer and the door sealing strip, resulting in poor refrigeration. The inner door shall be defrosted with an ice shovel attached to the biomedical freezer. The following steps are natural defrosting.

1. Shut down the auxiliary cooling device if any.
2. Remove items from the biomedical freezer and transfer them to an environment suitable for storage.
3. Turn off the power switch
4. Open the outer and inner doors to allow the biomedical freezer to open naturally for a period of time for defrosting.
5. Dry the accumulated water at the bottom of the biomedical freezer with a piece of dry cloth.
6. After cleaning the biomedical freezer and inner door, restart the biomedical freezer.
7. Put the items back into the fully cooled biomedical freezer.
8. If there is an auxiliary cooling device, restart the device.



Do not use knife, screwdriver or any other tool with a sharp edge to defrost.

Equipment out of Service

Out of service: If the biomedical freezer is to be stored unused in an unsupervised area for a long period, ensure that children do not have access to the biomedical freezer and that doors cannot be closed completely.

Scrap: The scrapping disposal of the biomedical freezer shall be carried out by corresponding professionals. In order to prevent something like suffocation, the biomedical freezer doors must be removed.

Optional Parts

Temperature Recorder

Please refer to the Temperature Recorder Instructions provided by the temperature recorder for use.



Please install the temperature recorder by professional technicians or after-sales personnel.



Please cut off the power supply before installing the temperature recorder; otherwise, electric shock or fire may occur.

Troubleshooting and Repair Service

Any product may fail. Please observe the operation of the equipment in time during use. If there is any abnormality, please check and handle it according to the table below. If the problem cannot be solved, inform our Service Center in time, and we will do our best to help you and avoid any loss.

Fault	Troubleshooting Method
Biomedical freezer does not work	Is the power circuit breaker normal?
	Is the power voltage too low?
	Is the power switch off?
	Is the fuse blown?
Poor cooling	Is the ambient temperature too high?
	Is the door closed tightly? (The frost between the biomedical freezer and the door sealing strip may damage the door sealing performance)
	Is the air inlet dirty and blocked?
	Are the condenser and filter screen dirty and blocked?
	Is the temperature set correctly?
	Is the biomedical freezer away from direct sunlight?
	Is the biomedical freezer close to the heat source?
	Are the rubber hole cover and insulation material of the test through hole properly placed?
Is a large amount of high temperature articles placed in the biomedical freezer for a short time?	
Excessive noise	Is the biomedical freezer installed on a solid and flat ground?
	Are other items contacted to the biomedical freezer housing?
	Is the base of the biomedical freezer leveled?



Note: If the fault cannot be eliminated after the above items are checked, or the fault is different from the above list, please contact the after-sales personnel.

Specifications

Name	Biomedical Freezer	
	VS-25L106	VS-40L106
Model No.	VS-25L106	VS-40L106
Climate type	N	N
Electrical shock protection class	Class I	Class I
Power supply	220~240V~/50Hz	220~240V~/50Hz
Temperature inside biomedical freezer	-10 ~ -25 °C	-20 ~ -40 °C
Refrigerant	R600a,55g	R290,50g
Cooling mode	Direct cooling	Direct cooling
Foam material	Cyclopentane	Cyclopentane
Total effective volume	106L	106L
Input power	115W	230W
Power consumption	0.73kWh/24h	1.93kWh/24h
Rated current	0.7A	1.5A
Weight	39kg	43kg
Product dimensions (W * D * H)	595*615*812mm	595*615*812mm

Name	Biomedical Freezer	
	VS-25L308	VS-40L308
Model	VS-25L308	VS-40L308
Climate type	N	N
Electrical shock protection class	Class I	Class I
Power supply	220-240V~/50Hz	220-240V~/50Hz
Temperature inside biomedical freezer	-25°C ~-10°C	-40°C ~-20°C
Refrigerant	R290,110g	R290,118g
Cooling mode	Direct cooling	Direct cooling
Foam material	Cyclopentane	Cyclopentane
Total effective volume	308	308
Input power	120W	195W
Power consumption	1.2kWh/24h	2.7kWh/24h
Rated current	1.18A	1.90A
Weight	100kg	102kg
Product dimensions (W * D * H)	700*690*1920mm	700*690*1920mm

Description of technical parameters: The technical parameters in this table are measured under standard conditions. After the parameters are changed due to product improvement and technical update, no further notice will be given, which shall be subject to the nameplate attached to the biomedical freezer.

Packing List

Name	Instructions	Key (as provided for lock)	Defrosting shovel	Handle (as configured)	Certificate of Conformity
Quantity	1	2	1	1	See the last page of the Instructions

Note: External padlock and handle optional accessories shall be subject to physical configuration.

Electrical Schematic Diagram

VS-25308/ VS-25L106

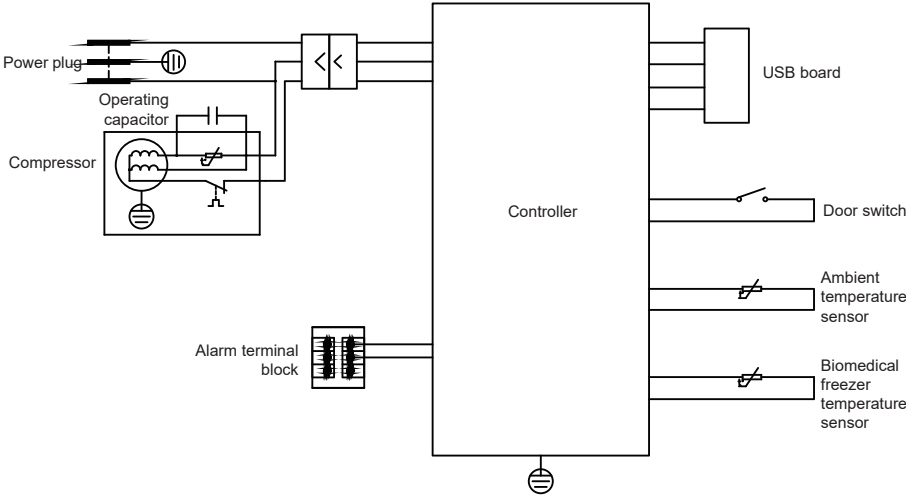

VS-40308/ VS-40L106

